

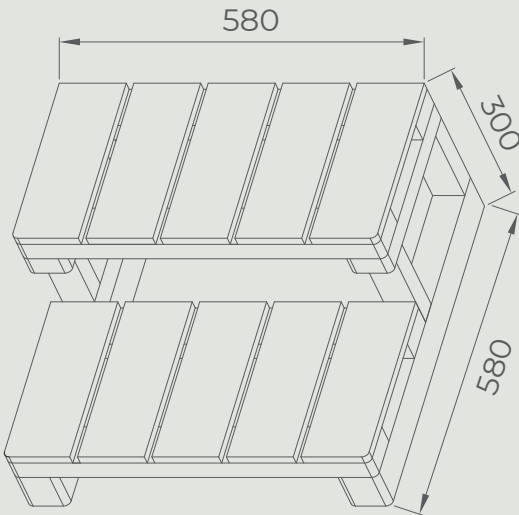





# Spa Step Guide

## Two Tier Instructions

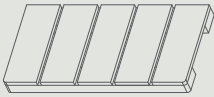
1. This diagram shows the dimensions of your spa steps.



2. Ensure the components below are present.

A	2PCS	B	2PCS
	Step Counter		Foot
C	12PCS	D	12PCS
	M6*40 Tightening Bolts		Screw Cap
E	1PCS	F	1PCS
	Tool		Manual

3. Place the step counter on the foot and fix it by using the tightening bolts and screw caps. It can be helpful to turn the foot upside down when doing so.

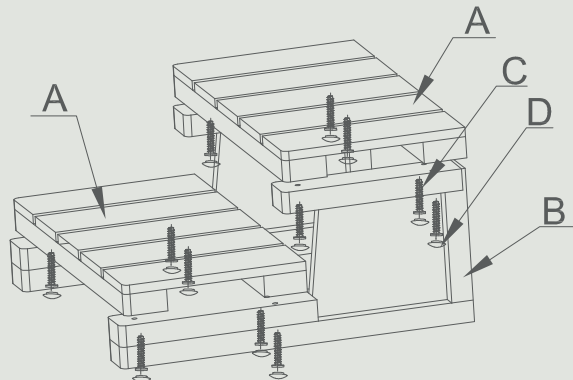





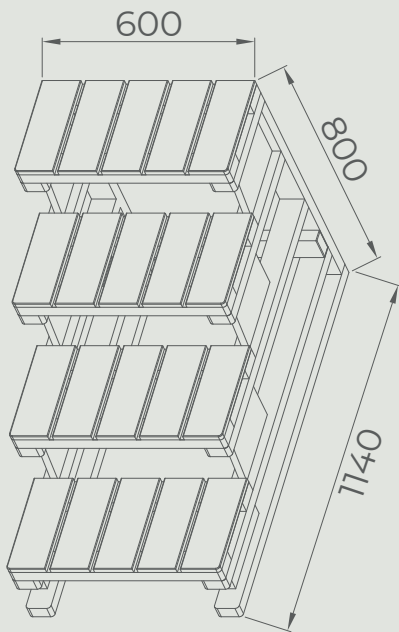

# Four Tier Step Instructions

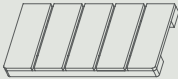
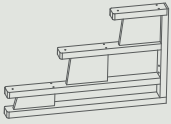
1. This diagram shows the dimensions of your spa steps.



2. Ensure the components below are present.

<p>A 3PCS</p>  <p>Step Counter</p>	<p>B 2PCS</p>  <p>Foot</p>
<p>D 18PCS</p>  <p>M6*40 Tightening Bolts</p>	<p>E 18PCS</p>  <p>Screw Cap</p>
<p>F 1PCS</p>  <p>Tool</p>	<p>G 1PCS</p>  <p>Manual</p>
<p>F 1PCS</p>  <p>Foot Ribs</p>	

3. Place the step counter on the foot and fix it by using the tightening bolts and screw caps. It can be helpful to turn the foot upside down when doing so.

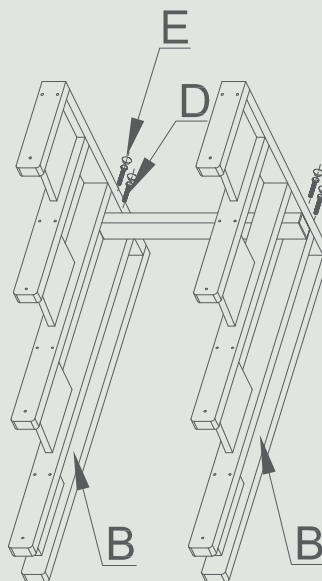

4. Place the step counter on the foot and fix it by using the tightening bolts and screw caps. It can be helpful to turn the foot upside down when doing so.

