



GALAXY SPAS

Your Spa Pool Guide

Draco I • Ara I

Introduction

This document will guide you through the process of becoming a Galaxy spa owner, preparing you for the delivery and installation of your spa pool and its accessories.

Many important considerations and actions are required so please read this guide thoroughly and refer to the pre-delivery checklist before the arrival of your spa.

You can find a wide range of support content and videos for spa owners on our website's [support page](#).



Contents

Draco I
04



Ara I
05



Pre-Delivery Guide	06
Delivery Options	07
Choosing Your Spa's Placement	08
Positioning Requirements	09
Foundation Requirements	11
Building Regulations and Consent	12
Pre-Delivery Checklist	13
Installation Guide	14
First Steps	15
Hard Cover Installation	16
Cover Lifter Installation	17
Electrical Installation	23
Filling Your Spa	24
Draining Your Spa	25
Gecko Touchpad Start Up Guide	26
Water Guide	32
Galaxy Super Chlor Start Up Kit	33
simplesilver™	37
Safety Information	40

Draco I

TRANSFORM SERIES

People
5

Size (m)
2 x 2 x 0.82

Jets
46

Insulation
5 layer

Pumps
1 + 1 Circ

Amps
15-25

The Galaxy Draco I is a 15 amp family spa pool that delivers transformative massage and hydrotherapy through dual loungers, three seated positions and 46 powerful jets. Five layers of insulation reduce the day-to-day running costs of this pool, as does the Gecko smart touchpad with WiFi and heat pump compatibility. One-touch settings make for a tranquil spa experience.



Acrylic
Sterling silver

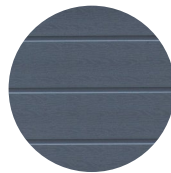

Cabinet
Slate grey

Seating
5 people

Size (m)
2 x 2 x 0.82

Controller
Gecko controller

Pool body
5 layer insulation
Injection moulded acrylic base
Treated timber frame
ABS base
Horizontal cabinet
Waterfall

Jets
28 massage jets
18 air jets

Water capacity
960L

Lighting
Water level lighting

Weight dry
334kg

Weight filled
1,294kg

Pumps
3hp massage pump
Circulation pump

Filtration
Ozone and Venturi

Heater
3kW

Amps
15A

Jet system
Starry sky jets and fittings

Optional extras
2-tier steps
Heat pump
WiFi unit

Warranty

10
YEARS Structural

5
YEARS Acrylic

5
YEARS Heaters & jets

2
YEARS Equipment

Ara I

TRANSFORM SERIES

People
6

Size (m)
2 x 2 x 0.82

Jets
40

Insulation
5 layer

Pumps
1 + 1 Circ

Amps
15-25

The Ara I is a spacious 15 amp pool designed with the whole family in mind. A single lounger and five seated positions comfortably seat six whilst providing advanced relaxation through its 40 hydrotherapy jets. The Ara I's Gecko touchpad's smart settings make for a tranquil user experience, with heat pump and WiFi compatibility and five-layer insulation prioritising running economy.



Acrylic
Sterling silver

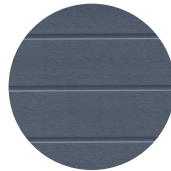

Cabinet
Slate grey

Seating
6 people

Size (m)
2 x 2 x 0.82

Controller
Gecko controller

Pool body
5 layer insulation
Injection moulded acrylic base
Treated timber frame
ABS base
Horizontal cabinet
Waterfall

Jets
28 massage jets
12 air jets

Water capacity
960L

Lighting
Water level lighting

Weight dry
310kg

Weight filled
1,270kg

Pumps
3hp massage pump
Circulation pump

Filtration
Ozone and Venturi

Heater
3kW

Amps
15A

Jet system
Starry sky jets and fittings

Optional extras
2-tier steps
Heat pump
WiFi unit

Warranty

10 YEARS Structural

5 YEARS Acrylic

5 YEARS Heaters & jets

2 YEARS Equipment



SECTION 1.

Pre-Delivery Guide

Everything you need to plan and consider before
your Galaxy spa arrives.

Delivery Options

Your spa consultant will speak with you about where you would like to place your spa pool and about access for delivery. Together you will decide which delivery method is best suited. Once you have purchased your spa, your consultant will hand you over to Galaxy's fulfilment team. One of our fulfilment managers will then be your point of contact and support to coordinate delivery.

Into position delivery.

A HIAB is the most common delivery method for a spa pool, consisting of a large delivery truck with a crane arm that can reach 7m long and 2m high, capable of lifting your spa into position from your driveway or street front. Manpower is used when a HIAB cannot reach your desired position.

Bespoke delivery.

A more complex delivery may require bespoke methods, usually utilising a combination of HIAB, manpower, crane or helicopter. To coordinate this, we will ask you to provide specific details about your property via descriptions and images. Factors such as powerlines, road and driveway access and natural obstacles will be considered. If needed, we will arrange a site check and quote.

Kerbside delivery.

If you are looking for a more economical option or are not ready to have your spa put into position, we can coordinate delivery to your kerbside. The spa will arrive on its side, in its packaging and then you will be responsible for moving it from here. We recommend talking to us about the best way to move it safely.

Pick up.

In certain scenarios, pick up from the nearest depot can be organised.

Requirement to inspect the spa upon delivery.

When your spa is delivered, you need to be present and do a thorough inspection of the spa before accepting delivery. This includes removing the outer packaging and ensuring no damage has occurred during freight. Claims for damage can only be accepted if issues are written on the consignment / delivery note you'll be asked to sign and communicated to Galaxy Spas within 24 hours of delivery.

Choosing Your Spa's Placement

For the best spa experience, the placement and orientation of your new pool should be carefully planned. There are important positioning, foundational and electrical requirements outlined in this section to ensure smooth delivery and installation. Refer to the checklist on page 13.

Whether to ensure a private sanctuary, have line of sight to supervise your kids in the spa, or to entertain guests easily, here are our top three considerations when designing your outdoor spa space.



1. View

What would you like to look at while you soak, relax and connect with loved ones? If your chosen spa has loungers, where or what would you want them to face?



2. Privacy

If privacy is important to you, think about the most private place for your pool. Consider neighbours, somebody coming to the door and sight lines of people walking or driving past.



3. Weather

Where is the most sheltered spot you can place your spa? Out of the wind and in the sun is ideal and not too far from the house for those chilly nights. If you are in a particularly hot and sunny climate, a slightly more sheltered spot is advised to reduce prolonged high UV exposure, to protect both those in the spa and the spa itself.



Positioning Requirements

Fencing

To keep you and your loved ones safe, most councils have rules around fencing requirements for spa pools.

Above ground

- + No fencing is required if your spa pool is above 0.76m high.
- + Spa pools are required to have a hard, lockable cover.
- + Any permanent structures near the spa (such as a heat pump) are classed as climbable surfaces and must be placed at least 1.2m away.

Draco I and Ara I - At 0.82m deep, no fencing is required.

Below ground

If you are sinking your spa pool into the ground or decking, a fence is required for safety compliance.

We recommend contacting your council to discuss any fencing requirements for your region. Fencing is the homeowner's responsibility and we want you to have the safest spa environment and adhere to any local spa fencing bylaws.

See page 12 for further details on building consent.

Electricity

Important Considerations.

- + Does your home have the electrical capacity to run a 15 amp spa? Most homes are able to.
- + Based on proximity to your power supply, are there particular areas you can or cannot place your spa? This may be an important consideration if you have a large property.
- + A 15 amp spa requires an outdoor waterproof 15 amp electrical socket.
- + An RCD (Residual Current Device) will need to be installed to protect the circuit and spa pool. A qualified electrician must install this before your spa is delivered. You may need to discuss this with your electrician before confirming your spa's positioning.

See page 23 for full electrical installation guidelines.

Service Area

Your spa's panels may need to be removed during servicing, so you must ensure there is enough room for a technician to access and remove them to complete the work. 50cm is the minimum requirement.

Cover Lifter

A cover lifter is a helpful accessory that attaches to your spa pool to assist you in removing your spa pool cover. Spa pool covers are heavy due to being constructed with thick insulating material to prevent hot air from escaping. Not only does a lifter help you remove the cover with ease, it also protects the cover from damage during the process.

Draco I and Ara I.

50cm rear and 10cm side clearance is required (5cm on each side).

You will need to lift your empty spa slightly to install the cover lifter correctly. Once filled with water, it will be too heavy.

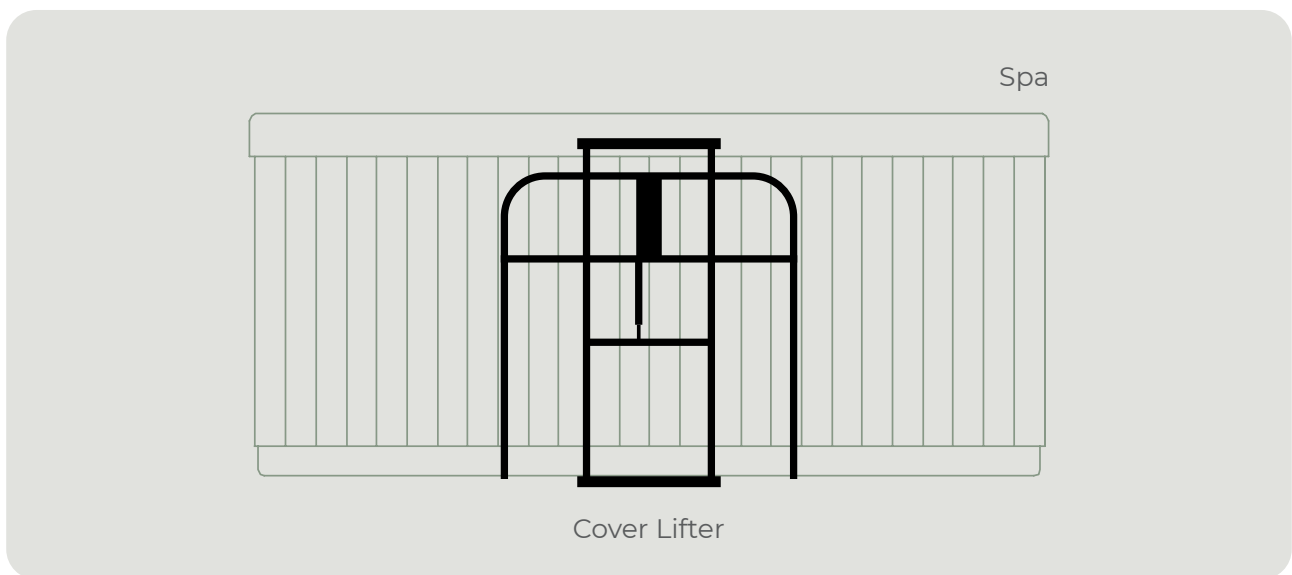

Cover Locks

- + The spa cover requires 32.5cm of space from the top of the installed cover down each side of the cabinet to the lock clips.
- + This space is required. Not providing the necessary clearances will mean you cannot install your cover properly or lock it.
- + Even when your spa is fenced, we recommend locking your cover locks to prevent the wind from dislodging the cover and unattended children from entering the spa.

Heat Pump

- + Your spa is heat pump compatible.
- + If purchase this add-on, it must be placed a minimum of 1.2m away from the spa so that it cannot be used as a climbable surface.
- + There must be a minimum 3m clearance in front and 1.5m clearance behind the heat pump for it to efficiently circulate airflow.
- + The heat pump needs to be on a concrete foundation.

For more information, please refer to the [Heat Pump Installation Guide](#) found on our website.

Foundation Requirements

Once full, your new Galaxy spa pool can weigh over two tonnes, so it needs to sit on a level surface that supports the entire base.

Concrete Foundation

We recommend a cured concrete pad with a minimum thickness of 10cm, slightly larger than your spa's dimensions.

Decking

It is common to place a spa pool on a deck or patio. If doing so, you must ensure that an engineer or builder checks the deck load rating before placing the spa pool.

Spa Steps

Steps need a flat, level foundation to sit on. Do not fix them in place, as they are then deemed a climbable object.

Two tier steps dimensions:

- + Length: 60cm
- + Width: 58cm
- + Height: 30cm



Drainage

Water splashing over the side of a spa pool is very common. Children playing or having a spa pool full of people is all part of the experience.

- + Drainage must be considered to prevent water from pooling around the spa's base. Flooding issues are not covered under warranty. We recommend incorporating drainage channels into your foundation to direct water away from the spa pool.
- + You will also need to consider drainage when changing your spa's water. A hose attachment comes with your spa. We recommend having a dedicated piece of hose long enough to reach your wastewater or garden.
- + If you are draining the water onto your grass or garden area, remember to let the water temperature drop first.

Building Regulations and Consent

Building Code Compliance

As the homeowner, you are responsible for understanding and complying with legislation and local bylaws related to installing a spa pool.

- + Your local council may have additional rules and regulations you must adhere to.
- + Building consent is required for some installation applications (outlined below).

Placement and Landscaping Considerations

Above ground installation.

This is the most common installation form, where the spa is placed on a concrete foundation.

In ground installation.

If you choose to sink the spa below the ground or build a deck around it, there are a few considerations you will need to take into account.

- + Building consent - you will need to install a fence around your spa and deck to prevent unaccompanied minors and animals from climbing onto / into the spa. The fence will require building consent.
- + Clearance - ensure decking supports are positioned 50cm away from the side of the spa. It is common to install removable decking around the spa for this purpose.
- + In ground installation considerations:
 - How will you access your drain valve at the base of your spa? This will need to be accessible to drain your spa pool.
 - Is there sufficient space / clearance for the servicing area, desired accessories (steps, cover lifter) and clips for the lockable cover?
 - If the clearance for the cover clips cannot be achieved, consider clipping the cover into the deck.

Pre-Delivery Checklist

1. Have you checked your property's access and discussed delivery access with our team?

2. Have you considered your chosen spa placement's view, privacy and weather conditions?

3. Have you checked if you need to fence your spa?

4. Do you need to arrange any electrical requirements before delivery?

5. Have you considered the service area, cover lifter and cover clip clearances?

6. Do you have a concrete pad foundation with room for steps?
OR
Has the deck load rating been checked if the spa is being placed on a deck?

7. Is your spa's fencing or decking building code compliant?

8. Have you planned for adequate drainage solutions?

9. Have you arranged to be on site during delivery and do you understand the obligation to inspect your spa before signing the consignment / delivery note?

10. Have you read the Installation Guide below and completed any pre-delivery or at the point of delivery actions?

Notes:

SECTION 2.

Installation Guide

Everything you need to know once your spa pool arrives.



First Steps

1. Remove the spa's packaging.

This includes the plastic outer and the thermal wrapping, which you may wish to save for future use.

2. Assemble your cover lifter.

Once the spa is full, it will be too heavy to lift and you will not be able to fit your cover lifter. We recommend assembling the cover lifter before delivery so that you can attach it once the spa is placed into position.

See full instructions on page 17.

3. Assemble your spa steps.

Your spa steps will not be fixed to the spa, so you can assemble these at any time.

Full instructions will arrive with your steps.



Hard Cover Installation



1. Position the spa cover on the spa, ensuring that the spa skirt is smooth and not folded in any location.
2. Pull the spa strap tightly downward, then press the buckle against the spa cabinet.
3. Whilst holding the buckle against the cabinet, release the top strap from the buckle by pressing the sides and unclipping. Mark the three mounting locations where you will screw the base of the buckle onto the cabinet.
4. Use the supplied screws to secure the base of the buckle onto the cabinet.
5. Repeat steps two-four for the remaining straps.
6. You should now be able to tightly and safely secure your spa cover to the cabinet.

Cover Care







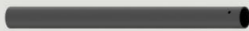
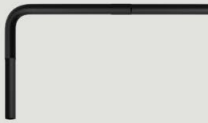

- + Avoid exposing the cover to excessive chemicals. Always remove the cover when adding your spa chemicals. Any texture change or extreme discolouration of the base material indicates a chemical burn.
- + Use a mild detergent and water solution to clean the vinyl portion monthly. Keep the cover clean and free of dirt and debris to avoid colour leaching.
- + Avoid water and snow from accumulating. These can cause the cover to sag and become water-logged, which will deteriorate the cover.
- + Avoid scraping the cover on rough surfaces. Avoid jerking or pulling the cover, especially when vinyl is soft from heat, to prevent threads from tearing the vinyl.
- + Always unfasten all hardware before opening the cover. Gently fold down the cover onto itself.
- + Do not sit, walk, or lay on the spa cover. Avoid placing any heavy objects on the cover.

Cover Lifter Installation

Before Starting

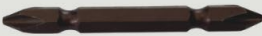
- + You will need a drill and a tape measure.
- + Please ensure all parts listed are present in preparation for the assembly of your cover lifter.
- + All left-to-right instructions are from standing in front of the spa.
- + Ensure your spa is placed onto a level surface, such as a concrete pad or load-checked decking.
- + Ensure you have the necessary clearances for your cover lifter as set out in your spa manual.
- + Ensure your cover is placed properly on your spa, centred and without folds in the cover skirt.

Parts List

	2 x Base Bracket		4 x Straight Coupler Tube
	2 x Bent Arm without Foam		2x Bent Arm with Foam
	38 x 3/4" Black Tek Screw		38 x Black PVC Push Cap
	1 x Phillips Diver		1 x 1/8" Drill Bit
	16 x 1" Metal Screw		2 x Cover Saver 2 x Velcro Patch
	2 x Nylon Pivot Strap		

Instructions

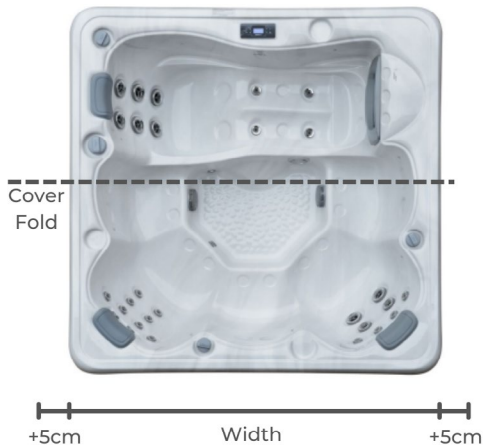

Figure 1.

Step 1.

The cover lifter must be assembled to the dimensions of your spa.

If your spa is square, you can choose the orientation of your cover and the side on which you install the lifter.

The framing tubes are slidable. Use your spa dimensions and add 5cm on each side to allow space for movement, as indicated by the table below. This is explained further in step 5.

Note, If your spa is rectangular, install the cover lifter on the shortest side (the width).

Spa Pool Model	Spa Pool Dimensions (length x width x depth)	Total Cover Lifter Width
Draco I	2m x 2m x 0.82	200cm + 10cm = 210cm
Ara I	2m x 2m x 0.82	200cm + 10cm = 210cm



Figure 2.

Step 2.

Place the **base brackets** on the ground with the flat side facing the spa. You can either slide them under the base of the spa or prop your empty spa up slightly.

Note, it does not matter exactly where they are placed, as long as they are square to the spa, as a tube will go through them.



Straight Coupler Tube

Figure 3.

Step 3.

Place one **straight coupler tube** between the two brackets.

Step 4.

It is optional to screw the base brackets to the base of the spa from within the cabinetry, or onto decking (if placing the spa on a deck). However, the weight of the spa once filled with water will be sufficient to hold the bracket securely. Use the **metal screws** if you plan to permanently secure it.



Bent Arm Without Foam

Figure 4.

Step 5.

Place the **bent arm without foam** through the tubular hole (circular part on the bracket).

Important:

- + If the width **is less than 2m**, connect the **short ends** to the straight coupler.
- + If the width **is 2m or more**, connect the **long ends** to the straight coupler.



Total length: Spa width + 10cm

Figure 5.

Step 6.

Once you have connected the **bent arms without foam** to the **straight coupler tube**, ensure that the length corresponds to your spa model (see the chart in step 1) by sliding the tubes to the appropriate length.

The spa pictured is 2m x 2m, so the long ends are shown to be connected to the straight coupler.



Figure 6. Straight Coupler Tube

Step 7.

Place another **straight coupler tube** to the other end of the **bent arm without foam** on the right and the left. You can keep them lying flat on the ground for now.



Side Straight Coupler Tube
Nylon Strap Bracket

Step 8.

Slide **nylon pivot straps** over each of the **straight coupler tubes** on each side.

Ensure that the bracket is facing the spa on each side. You will attach this to the side of the spa in step 16.

Figure 7.

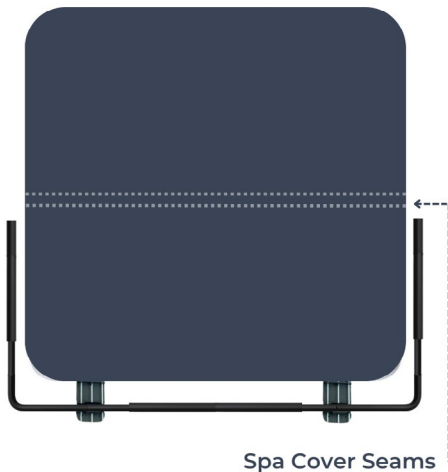

Figure 8.

Step 9.

Ensure the cover is closed and is square on the spa.

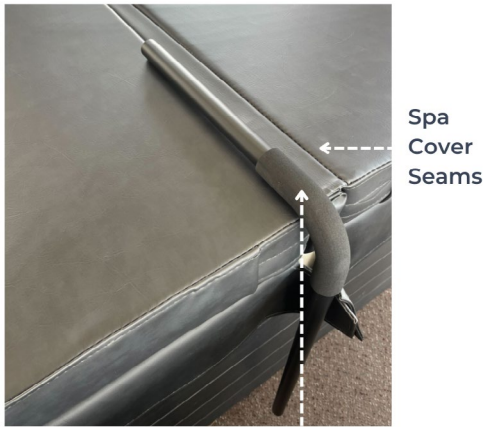

Figure 9. Bent Arm with Foam

Step 10.

Place **bent arms with foam** in front of the centre seam of the cover as shown. Do this for the left and right side.

Important:

- + If the length of the face parallel to the cover **is less than 2m**, place the short ends on the seam of the spa.
- + If the length of the face parallel to the cover **is 2m or more**, place the long ends on the seam of the spa.

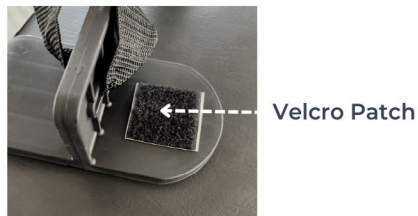
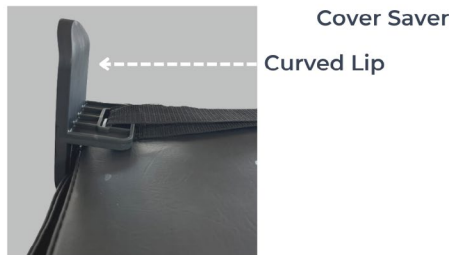

Figure 10.

Step 11.

Loop the **cover saver strap** over the top horizontal section of the straight arm with foam as shown.

Ensure the curved lip of the end bracket is facing upwards.

Use the **velcro patch** to attach the bracket to the spa cover.

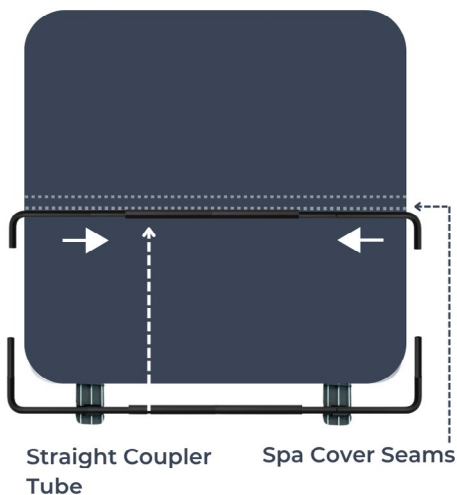

Figure 11.

Step 12.

Use the last **straight coupler tube** to connect the two bent arms.



Figure 12.

Step 13.

The white dotted arrow demonstrates the importance of the 5cm allowance space for the cover lifter to move without damaging the spa cover.

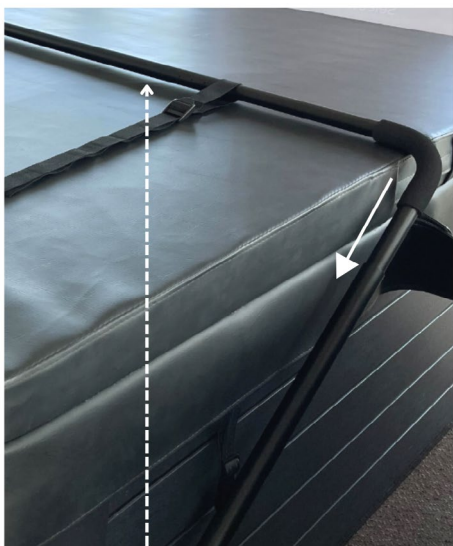

Side Straight Coupler

Figure 13.

Step 14.

Slide the long ends of the **bent arms with foam** into the side **straight coupler tubes**. Now the four bent arms and the four straight coupler tubes make up a square frame. Ensure that the straight coupler is centred slightly forward of the cover seam.

Step 15.

Screw all four **straight couplers** using the **3/4" black tek screw**. There are six per coupler. There are three holes on each end of the couplers. Once you have aligned everything perfectly, use the hole as a guide to drill a hole through to the inner tube. They are smaller than the screws, but a drill will drive the screws through.

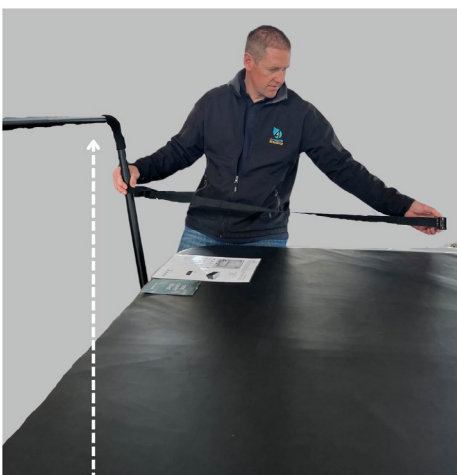

Assembled frame in upright position

Figure 14.

Step 16.

Lift the assembled cover lifter frame into the upright position, approximately at 20 degrees. Stretch the **nylon strap** towards the centre of the spa. Secure it near the top of the cabinet by using the **1" metal screw** provided. Repeat on the other side.

Step 17.

Install **black PVC push caps** on each of the screw heads.

Step 18.

Fasten the strap onto the side coupler bar using the **3/4" black tek screw** provided.

Step 19.

The cover lifter is now installed and ready to use.

Electrical Installation

A registered electrician must complete all electrical work to be covered under our warranty. Galaxy Spas is unable to arrange or advise on electrical services.

By this stage, you should have your RCD and 15A outdoor electrical socket installed.

15 Amp Spa Pool

Draco I and Ara I.

1. 15 amp spas come with a 4m power cable.
2. The power cable will be located inside the cabinetry on the same side as your controller. By removing the panel, you will be able to locate your power cord which is attached to the frame above the control box.
3. You can now plug your spa into your outdoor electrical socket.

Removing the side panel to access componentry.

1. Remove the adjacent corner panels by gently pulling the panel out, up slightly and then down over the bottom lip of the spa.
2. Unscrew the cabinet's screws which will now be exposed. Using a standard screwdriver, place the screws safely to the side.
3. Lift the cabinet up and then slide out from the base down.

Componentry Locations.

Draco I

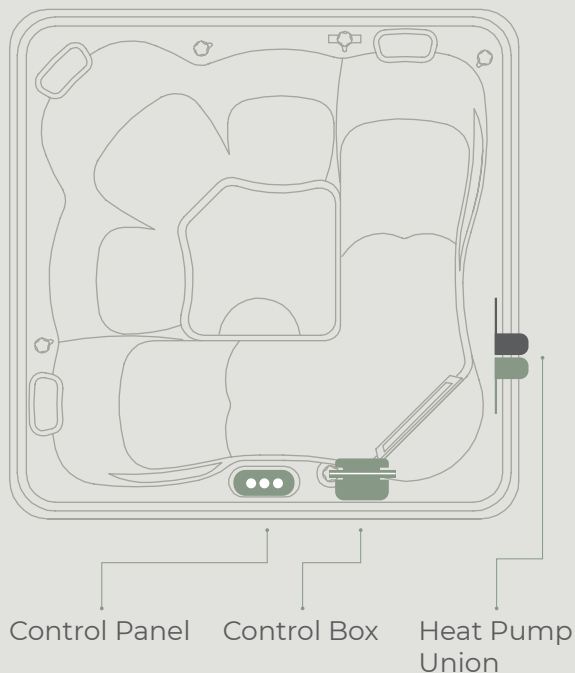

Ara I

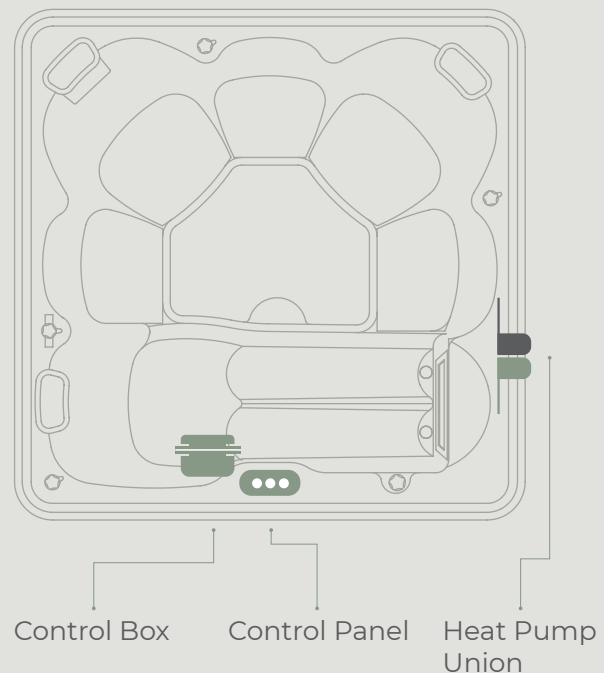

Filling Your Spa

We water test each spa at our factory and water residue may remain in the pipework. You may notice a smell related to this and may also notice some residue on or in the spa that has settled during production, testing or transport. This is completely normal and therefore, it is important you wipe out and then sanitise your spa prior to first use, following the steps below:

1.



- + Make sure the power to your spa pool is turned off.
- + Remove one of your filters and place your garden hose into the filter basket (this will help to prevent air locks in the plumbing).

2.



- + Fill the spa pool to the recommended fill line, indicated by the sticker on the inside of the spa.
- + Remove the hose and place the filter back into the filter basket.

3.



- + Once full, turn on the power to the spa pool.
- + A priming cycle will automatically run, clearing the pipes and testing the components.
- + Set your spa time and filtration cycles, following the touchpad guide on page 26.

4.



- + Add the recommended chemicals to the water using the Galaxy Super Chlor Start Up Kit guide on page 33, or the simplesilver guide on page 37.

5.

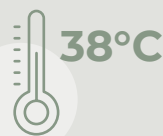

- + Set the spa pool to your desired temperature.

6.



- + Ensure your cover is down and tightly secured, then allow the spa pool to heat (six+ hours).

Draining Your Spa

You will need to know where the drain valve is located so that you can change your water.

Draco I

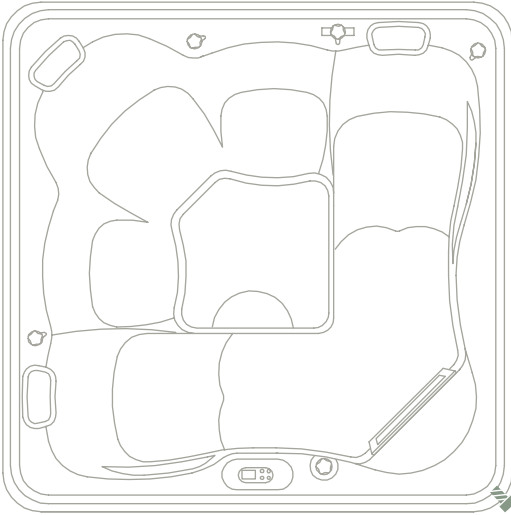

Drain Valve

Ara I

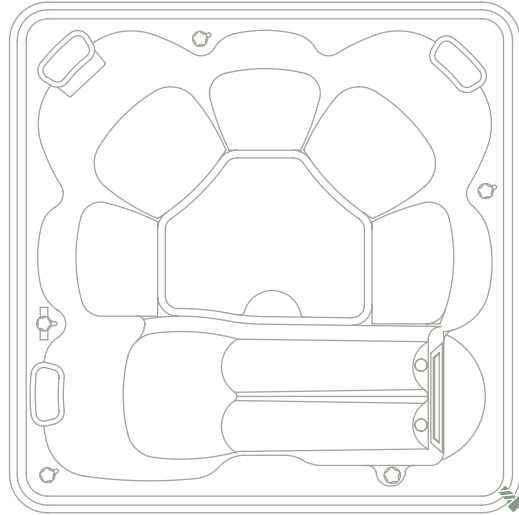

Drain Valve



1. Twist the drain dial half a turn clockwise. Pull on it slightly until it comes out around an inch.
2. Unscrew the dial's retaining cap and attach the draining connector.
3. Push in slightly to start draining.
4. Pull out to stop draining mid flow.
5. Attach a hose to drain to your desired location.
6. Replace the drain dial when finished.

Gecko Touchpad Startup Guide

Gecko Touchpad



This guide will help you to set up your Gecko touchpad when your spa first arrives. Gecko componentry has a superb reputation for build quality, reliability and ease of use.

Reminders, Maintenance Settings, Troubleshooting.

For information on the above functions and general troubleshooting, please click this [link](#) to download our full Gecko guide. Otherwise, if you have printed this guide, please visit www.galaxyspas.co.nz/support to view the full document online.





Instructions

Turn Keypad On

Turn the keypad on using the all-on or all-off button.

Modes

The main modes are located along the left hand side of the icon wheel. Please note that due to being a universal touchpad, keys are featured for additional add-ons that we have opted not to use. We will explain which keys are not functional on the following page.

Icon	Function
	<p>Spa mode</p> <p>Control your temperature, jets, lights and display.</p>
	<p>Settings</p> <p>Control filtration cycles, spa modes and more.</p>
Icon Not applicable for Galaxy Spas	
	<p>Sanitization mode</p> <p>Sanitization with in.clear connected. We use a state-of-the-art mixing chamber system instead.</p>
	<p>Colour mode</p> <p>Colour with in.mix installed.</p>
	<p>Audio mode</p> <p>Audio with in.stream installed.</p>

Spa Mode

To select a spa mode, slide the left wheel up or down until the spa icon is highlighted in the middle. The home page will display your spa features buttons, up and down buttons, water temperature, messages and quick access to display options (display orientation and contrast). To select an option, slide the right wheel up or down until the desired icon is highlighted in the middle.

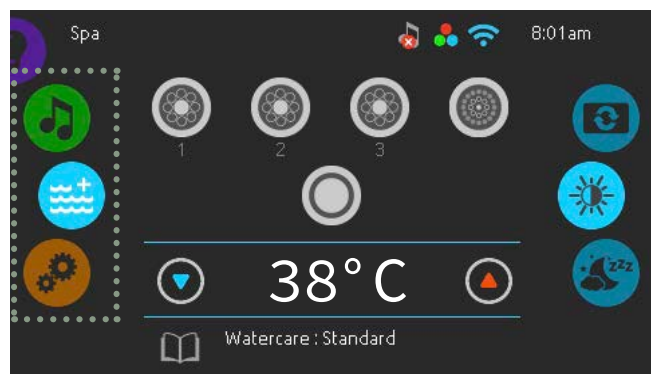

Start or Stop Accessories

Touch the associated icon to start or stop a feature such as your massage pump/s, air blower and lights. Icons will become animated when their feature is turned on.

Lights

Press the centre button, highlighted yellow in the image to the right. Press again to change the colour to your desired setting.

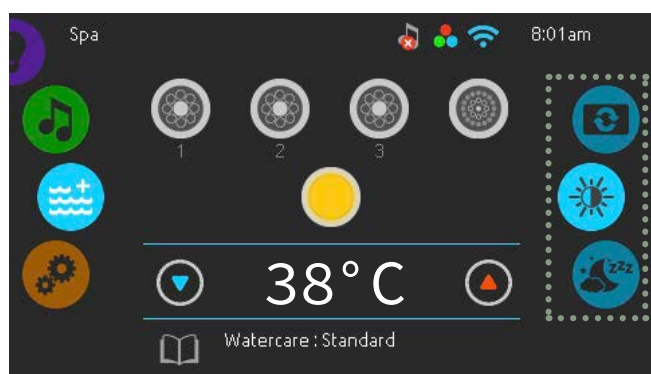

Water Temperature

The temperature at the bottom of the screen indicates the current water temperature. Use the up and down icons to change the desired temperature. The temperature you set your spa to will appear in blue. Do not leave more than three seconds between setting the temperature or the system will exit the process without saving.

When the set temperature is either higher or lower than the current temperature, you will see a message at the bottom of the screen saying either 'cooling' or 'heating' to the set temperature. There is usually a short delay before the heating starts, during which 'heating suspended' will be displayed on the temperature.

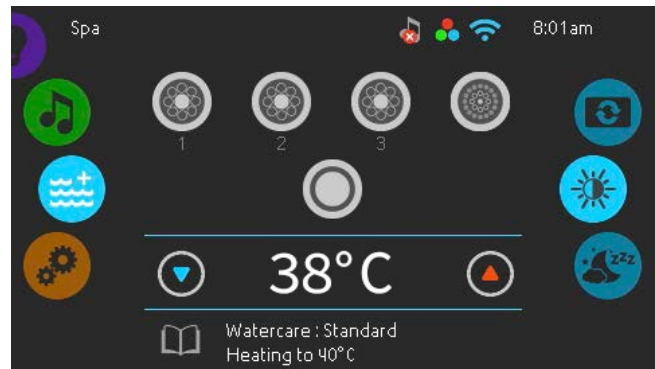

Display Orientation

You can invert the screen depending on where you wish to use your touchpad (either standing outside of the spa or sitting within). Use the right wheel to select the orientation and touch either normal or inverted, depending on your preference.

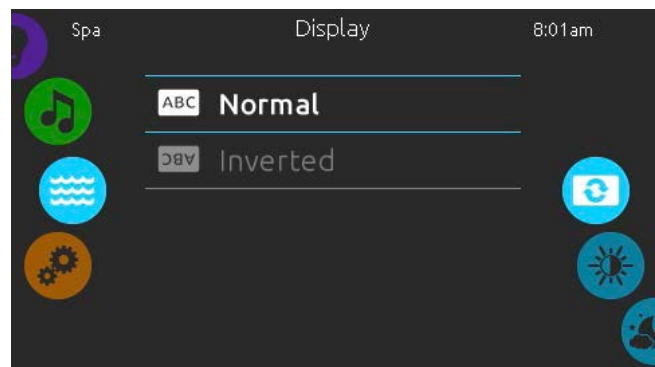

Display Contrast

Use the right wheel to select contrast and touch either day or night, depending on your preference.

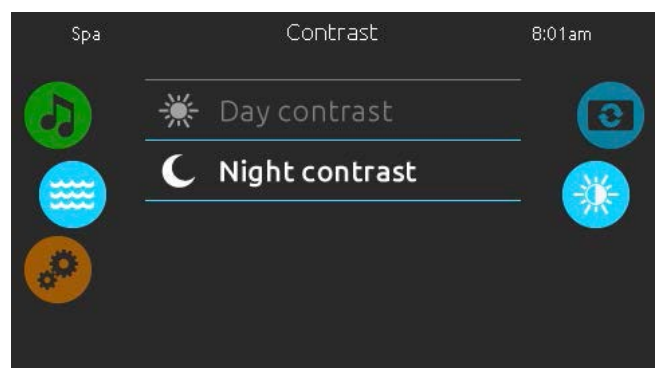

Sleep Mode

To modify the sleep settings, slide the right wheel until the display contrast icon is highlighted in the middle. Press the key in the centre to go directly into sleep mode. As touchpads are very sensitive equipment, we always recommend putting them into sleep mode when you are using the spa to ensure splashing water does not inadvertently engage a setting.

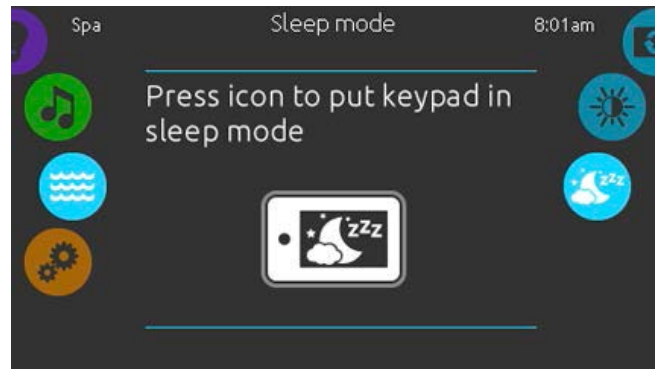

Settings



To select the settings mode, slide the left wheel up or down until the settings icon menu is highlighted in the middle. On the settings page, you can access the following:

- + Water care
- + Maintenance
- + Date and time
- + Keypad
- + Electrical configuration
- + WiFi
- + Miscellaneous
- + About

To select an item, slide the right wheel until the desired icon is highlighted in the middle or press on the menu name.

Water Care Settings

Choose, set or modify one of the five pre-set water care configurations below. In economy mode, your set temperature will be reduced by six degrees and the heating system will not be engaged unless the water drops further below this temperature. Why only six degrees? The colder your water is, the more expensive it is to heat.

Watercare Modes:



Away from home / economy mode - if you are going to be away from home for more than two weeks, select this mode. Your spa will be kept in economy mode and perform only the filtration it needs until you return. Your heater will only turn on if the water temperature drops six degrees below your set temperature.



Standard / beginner - if you want to use your spa as often as possible without having to change settings, select this mode. The spa heater will turn on every time the water drops below your set temperature, ensuring it is nice and hot whenever you wish to bathe.



Energy savings - select this mode if you wish to only use your spa during weeknights and weekends. During peak hours, your spa will be in economy mode and will not filter or heat unless the water drops six degrees below your set temperature, saving you in running costs. As evening approaches and on Saturday and Sunday, the spa will move into standard mode and the filtration cycle and heater will switch on, ensuring a warm bathing experience. You will need to manually add your economy times based on when your power company charges the most for power. If you are not sure when this is, or you want to ensure the spa is always warm by the time you get home from work, we recommend setting your economy mode time frame from 4 am-4 pm, remembering that it takes approximately one hour to heat your water by one degree. Play around with this timeframe until you reach a point where your water temperature is perfect by the time you enter the spa.



Super saver - select this mode if you only want to use your spa during the evenings, even on the weekends. During your selected peak hours, your spa will switch into economy mode. As evening approaches, the spa will move into the standard mode, with the filtration cycle and heater switching on. As above, we recommend playing with your economy mode period to ensure your spa is warm when you wish to bathe.



Weekender - select this mode if you only want to use your spa on weekends. During the week, your spa will be in economy mode. Come the weekend, the spa will switch into standard mode and your heater will ensure your water stays at your set temperature all weekend long.

Modifying Water Care Schedules

To modify the water care setting, touch the pen icon at the right end of the desired mode. Your spa's default setting is the standard - beginner mode, with two six-hour filtration times, starting at 12 am and 12 pm.

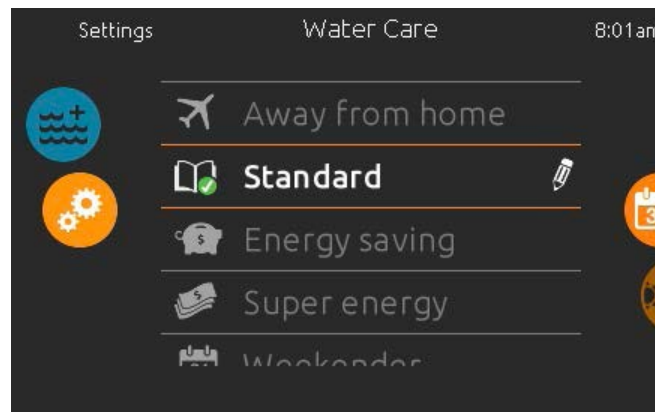

Filter Cycles

To modify a filter cycle, touch the cycle you wish to edit. You can change the date, start time (set in 30-minute increments) and filtration duration. These cycles will repeat every week. Once you have made your selection, press confirm. You can add an additional filtration cycle (if your spa was used more than usual on a certain day) by touching the orange line labelled 'add filter cycle'. To delete a schedule, touch the garbage can icon at the end of the desired line.

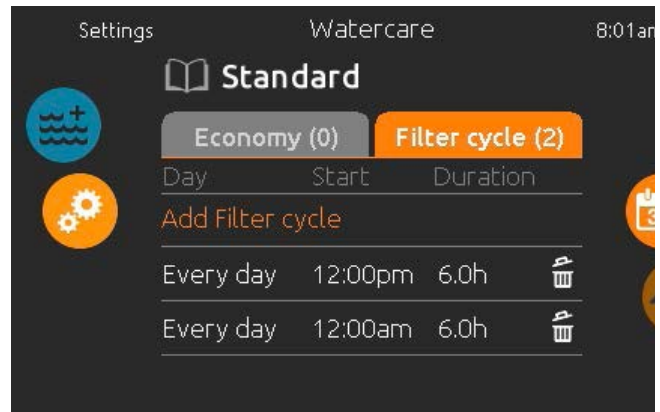

Economy

Add an economy cycle if there are specific days each week that you do not want to use your spa (away for work every Monday, ongoing weekly commitment every Tuesday etc.)

To add an economy cycle, touch the economy tab and press 'add economy'. To delete the schedule, touch the garbage can icon at the end of the desired line.

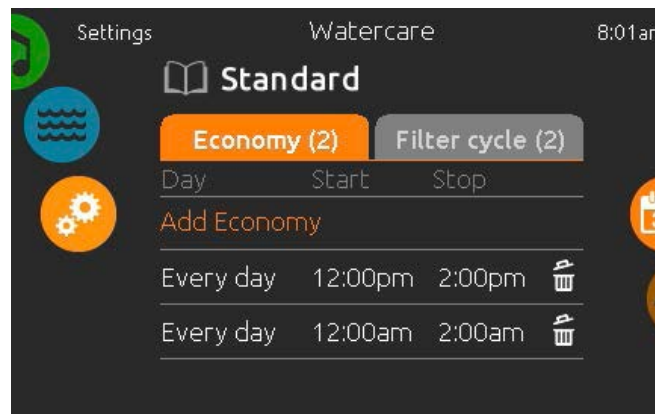

Diverters

Although you will use the touchpad to turn the jets on and off, diverters allow you to customise the massage pressure from seat to seat, diverting water between the spa jets. The diverter controls are located on the edges of your spa and look like this:

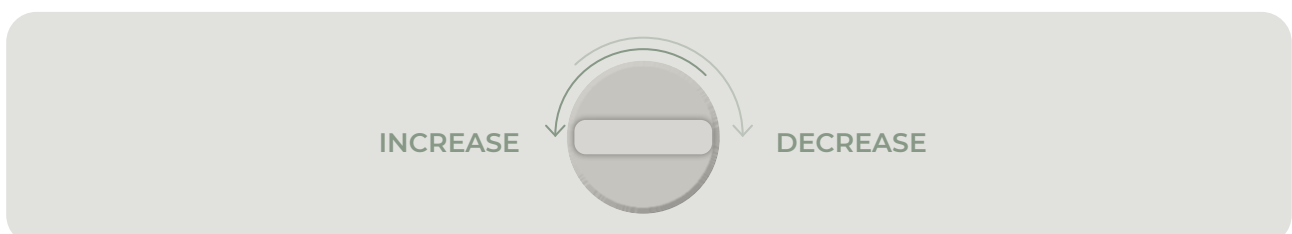

SECTION 3.

Water Guide

Everything you need to know about balancing your water for the first time. For ongoing maintenance and troubleshooting support, please visit www.galaxyspas.co.nz/support.

Refer to the relevant section based on your chosen water care.

Galaxy Super Chlor Start-Up Kit.....	33
simplesilver™.....	37

Galaxy Super Chlor Start Up Kit

Galaxy has engineered our chlorine system to be gentle on skin, soft in smell and of course, effectively sanitise your water.

Galaxy spa pools utilise a CD ozone system which takes care of 93% of water sanitisation. Super Chlor tops up the remaining 7% for superior water quality all year round.

Before Starting

Spa volume.

You will need to know your spa's volume (number of litres) to use the charts in this guide. Small deviations in the volume will not affect the water balancing.

Draco I 960L

Ara I 960L

First Treatment - Chlorine Shock Dosing

You must shock dose your spa the first time you fill it with water. Shock dosing refers to adding a higher than normal dose of chlorine to the water. This is extremely important for good long term water chemistry and ensures surface bacteria is killed before first use.

Super Chlor shock dose chart.

Spa	Draco I	Ara I
Shock dose	4 ½ tsp	4 ½ tsp

Instructions:

1. Remove your cover and headrests to protect the fabric.
2. Add Super Chlor to a bucket of water and mix to combine.
3. Add the bucket mix to your spa.
4. Run the pumps to mix for at least 20 minutes and then replace the cover and headrests.
5. Wait 24 hours after shock dosing before using your pool.

Shock dosing can also be carried out as part of normal maintenance if you notice your water is discoloured or not crystal clear.

Daily Treatment

Super Chlor should be used every day at roughly the same time, ideally straight after using the spa.

Super Chlor daily dosage chart.

Spa	Draco I	Ara I
Shock dose	2 ¼ tsp	2 ¼ tsp

Start Up Kit Contents

Below are the contents of the kit and how to use the products to achieve optimum water chemistry.

- + **AquaChek Test Strips** - used to test your water chemistry.
- + **Super Chlor** - used to disinfect the water and keep it fresh by killing any bacteria.
- + **pH Decrease** - if your pH is above 7.8, the water is too alkaline / basic. This can cause problems such as cloudy water and skin / eye irritation. You need to lower the pH to within the normal range (7.2 - 7.8) by using this product.
- + **Alkalinity Up** - if your alkalinity is not in the optimal range, you will have trouble maintaining a stable pH as it is easily affected by changes in the water. Use Alkalinity Up to increase the total alkalinity to the correct range, which helps to maintain the pH level.
- + **Water Hardener** - also referred to as total hardness. This product raises the calcium levels in the water and helps to prevent corrosion of pumps and heater parts. Town water supply generally contains an optimum amount of calcium and should require minimal balancing.
- + **Cartridge Cleaner** - a concentrated cleaning solution that removes dirt, oil, body fats, grease and film from filter cartridges.

Recommended Water Quality

It is important to check your chemical balance weekly.

When carrying out your water test, results should fit within these ranges.

	Minimum	Ideal	Maximum
pH ppm	7.2	7.4 - 7.6	7.8
Free Chlorine ppm	2.0	3.0 - 5.0	10.0
Alkalinity ppm	60	100 - 200	250
Calcium hardness ppm	150	200 - 400	500

- + ppm = parts per million.
- + Avoid testing immediately after a chlorine shock dose, as high chlorine levels can alter the test kit's accuracy.
- + Remember to ensure your chemicals are within their use-by date. Testing results may not be accurate otherwise.

Balancing Your Water

How to use testing strips:

1. Dip and remove the strip (do not shake).
2. Wait 15 seconds.
3. Compare strips to the colour chart on the AquaChek bottle.

Based on the results, treat the water using the charts below.

Helpful conversions:

- 3 teaspoons (tsp) = 1 tablespoons (Tbsp).
- 1 tablespoon (Tbsp) = 15 grams (g).
- 8 tablespoons (Tbsp) = ½ Cup.
- 16 tablespoons (Tbsp) = 1 Cup.
- 1 kilogram (kg) = 4.23 Cups.



pH Decrease - lowering total alkalinity and decreasing your pH levels.

Desired ppm decrease	Draco I	Ara I
.2	2 tsp	2 tsp
.4	4 tsp	4 tsp
.6	6 tsp	6 tsp
.8	8 tsp	8 tsp
1.0	10 tsp	10 tsp

Alkalinity Up - balancing total alkalinity with alkalinity up.

Desired ppm increase	Draco I	Ara I
10	1 ¼ Tbsp	1 ¼ Tbsp
20	2 ½ Tbsp	2 ½ Tbsp
30	3 ½ Tbsp	3 ½ Tbsp
40	4 ¾ Tbsp	4 ¾ Tbsp
50	6 Tbsp	6 Tbsp
60	7 Tbsp	7 Tbsp
70	8 ¼ Tbsp	8 ¼ Tbsp
80	9 ½ Tbsp	9 ½ Tbsp
90	10 ½ Tbsp	10 ½ Tbsp
100	11 ¾ Tbsp	11 ¾ Tbsp

Water Hardener - for increasing calcium content and total hardness

Desired ppm increase	Draco I	Ara I
50	4 ¾ Tbsp	4 ¾ Tbsp
100	¾ Cup	¾ Cup
200	1 ¼ Cup	1 ¼ Cup
300	1 ¾ Cup	1 ¾ Cup

Cyanuric Acid - once this gets to over 50, it is time to drain your spa.

Cartridge Cleaner - we recommend that you clean your spa's filters fortnightly:

- + Soak for 24 hours in a bucket with a cartridge cleaner.
- + Rinse with water and dry thoroughly to reduce frothing.
- + Place back into the pool.

Draining your spa - it is advised that you change your water every three months.

simplesilver™

What Is simplesilver™?

- + simplesilver™ is a combination of naturally occurring minerals and a small amount of silver oxide encapsulated in soluble silicon. Silver oxide is a chemical compound with oxidising properties used in cleaning applications.
- + simplesilver™ is proven safe and used in many water treatment applications worldwide.
- + simplesilver™ comes to you packaged in a rigid plastic container for easy use.
- + As this is a chlorine free option, it is recommended that you shower before using your spa.

How Does simplesilver™ Work?

- + simplesilver™ placed in your spa pool gradually releases its minerals into the water, removing contaminants and limiting the formation of scale and rust, while inhibiting the growth of bacteria.
- + All simplesilver™ needs to work well is a good flow of water passing over it, so you can place simplesilver™ just about anywhere you like in your spa pool.

How Do I Use simplesilver™ in My Spa?

Overview

As a first-time simplesilver™ user, whether you have a new or existing spa pool, you will need to ensure the system is clean by removing any contamination in the water, pipes or equipment. This may have occurred for various reasons, such as contaminated water left in the spa pool after factory testing, bacteria in the water that has propagated during shipping from the manufacturer, or in the case of an existing spa pool, substandard maintenance or water treatment.



Step One - Installation Process

There is no need to drain or change the water in your spa pool unless you were previously using bromine.

- + Place the simplesilver™ tablet anywhere in your spa pool water.

Dosage.

One 500g tablet is standard for spa pools with a volume of up to 1500L.

For larger spa pools or swim spas, you will need to use a larger volume tablet:

Spas	Spa Volume	Dose
Draco I	960L	1 x 500g Tablet
Ara I	960L	1 x 500g Tablet

Step Two - Filter Pump Set Up

4. You need to set your filter pump timer to operate daily.

- + Turn the filter pump onto the standard mode.
- + Turn off the sleep timer.
- + Turn off holiday mode.
- + Turn off energy-saving mode.
- + Make sure to open all jet heads and water features.

The filter circulation pump must be set up correctly to ensure 80,000 to 100,000 litres of water circulate daily. This ensures an accurate quantity of simplesilver™ minerals are eluted into the water to balance and control it.

5. Once the filter pump has been set, do not use your spa pool for the next seven days.

- + Removing contamination and dispensing the correct levels of simplesilver™ minerals will take about a week, after which you will have crystal clear, clean, odour-free water for the next year!

6. At the end of the seven day period:

- + Clean the filters with a cartridge cleaning solution, as water alone is ineffective.
- + Dry these before reinstalling. This will make the filters more effective as the fibers expand, stopping the water from foaming.

What is going on in my spa pool over this seven day period?

- + As the filter pump circulates the water over the simplesilver™ tablet, the minerals are distributed into the spa pool at a constant and controlled rate.
- + It takes time for the correct concentration of simplesilver™ minerals to be dispensed into the water to effectively control and balance the pH, alkalinity, total dissolved solids, scale, corrosion and bacteria.
- + During the first week, any existing contaminants within the spa pool are precipitated out into the water and it might turn grey. Do not panic, this is simplesilver™ doing its job. These contaminants are removed via the filters, which are cleaned by you after seven days.

Note, if you use the spa pool before the seventh day, there will not be sufficient simplesilver™ minerals in the water to inhibit the growth of bacteria or effectively balance the water, therefore the water will not be able to be maintained in a pristine, clear and clean condition.

Step Three - Use the Spa Pool

After the seven day resting period.

Clean your filters using a cartridge cleaning solution. If your spa pool water is crystal-clear, clean and odourless, you are good to go.

After Care

How long does simplesilver™ last?

simplesilver™ will keep your spa water clean and healthy for 12 months. To replace it, simply place a new block in your pool. We recommend changing your water and cleaning your filter before adding the new block.

What if I am having problems with simplesilver™?

There can be several variables that prevent simplesilver™ from working effectively. Whilst most can be resolved with troubleshooting and correct filtration, from time to time, it simply does not work for a customer.

If you are having problems, you can:

1. Visit the simplesilver™ website and use their troubleshooting page to see if you can solve the problem yourself.
2. Get someone from simplesilver™ to help you, they can often solve the problem by giving you advice over the phone or by email. Contact them via their website.
3. In the rare situation simplesilver™ proves ineffective in your spa, you can return it to where you bought it for a full refund. Simply return the block within 60 days of purchase (note you must present your receipt / proof of purchase as it contains the date of purchase).

Please visit [simplesilver.com](https://www.simplesilver.com) for full troubleshooting advice and more information.



Safety Information

We want your Galaxy spa experience to be enjoyable and relaxing. We care deeply about your spa safety, so please read through the guidelines below:

- + Ensure you have read and understood this guide thoroughly and have followed all the instructions outlined in this spa guide.
- + Closely supervise children at all times when using your spa.
- + Keep electrical appliances away from the spa water. Do not permit any electrical appliance, such as lights, telephone, radio, or television, within 1.5m of the spa.
- + Always check the spa's temperature before entering.
- + During pregnancy, seek medical advice about using your spa before doing so.
- + If you suffer from a medical condition or are on medication, seek medical advice about using your spa before doing so.
- + Monitor the length of time you spend in hot water to reduce chances of overheating, drowsiness or hyperthermia.
- + Ensure the surfaces around your spa are non-slip and always enter and exit your spa with caution to avoid slipping or injury.
- + Refrain from using your spa in severe weather conditions such as electrical storms.



GALAXY SPAS

Wishing you many relaxing
soaks in your new spa.